

Final Mark Scheme (Results)

January 2015

Pearson Edexcel International
Advanced level in Chemistry
(WCH04) Paper 01

Edexcel and BTEC Qualifications

Edexcel and BTEC qualifications come from Pearson, the world's leading learning company. We provide a wide range of qualifications including academic, vocational, occupational and specific programmes for employers. For further information, please visit our website at www.edexcel.com.

Our website subject pages hold useful resources, support material and live feeds from our subject advisors giving you access to a portal of information. If you have any subject specific questions about this specification that require the help of a subject specialist, you may find our Ask The Expert email service helpful.

www.edexcel.com/contactus

Pearson: helping people progress, everywhere

Our aim is to help everyone progress in their lives through education. We believe in every kind of learning, for all kinds of people, wherever they are in the world. We've been involved in education for over 150 years, and by working across 70 countries, in 100 languages, we have built an international reputation for our commitment to high standards and raising achievement through innovation in education. Find out more about how we can help you and your students at:

www.pearson.com/uk

January 2015

Publications Code IA040470*

All the material in this publication is copyright

© Pearson Education Ltd 2015

General Marking Guidance

- All candidates must receive the same treatment. Examiners must mark the first candidate in exactly the same way as they mark the last.
- Mark schemes should be applied positively. Candidates must be rewarded for what they have shown they can do rather than penalised for omissions.
- Examiners should mark according to the mark scheme not according to their perception of where the grade boundaries may lie.
- There is no ceiling on achievement. All marks on the mark scheme should be used appropriately.
- All the marks on the mark scheme are designed to be awarded. Examiners should always award full marks if deserved, i.e. if the answer matches the mark scheme. Examiners should also be prepared to award zero marks if the candidate's response is not worthy of credit according to the mark scheme.
- Where some judgement is required, mark schemes will provide the principles by which marks will be awarded and exemplification may be limited.
- When examiners are in doubt regarding the application of the mark scheme to a candidate's response, the team leader must be consulted.
- Crossed out work should be marked UNLESS the candidate has replaced it with an alternative response.
- Mark schemes will indicate within the table where, and which strands of QWC, are being assessed. The strands are as follows:
 - i) ensure that text is legible and that spelling, punctuation and grammar are accurate so that meaning is clear
 - ii) select and use a form and style of writing appropriate to purpose and to complex subject matter
 - iii) organise information clearly and coherently, using specialist vocabulary when appropriate

Using the Mark Scheme

Examiners should look for qualities to reward rather than faults to penalise. This does NOT mean giving credit for incorrect or inadequate answers, but it does mean allowing candidates to be rewarded for answers showing correct application of principles and knowledge. Examiners should therefore read carefully and consider every response: even if it is not what is expected it may be worthy of credit.

The mark scheme gives examiners:

- an idea of the types of response expected
- how individual marks are to be awarded
- the total mark for each question
- examples of responses that should NOT receive credit.

/ means that the responses are alternatives and either answer should receive full credit.

() means that a phrase/word is not essential for the award of the mark, but helps the examiner to get the sense of the expected answer.

Phrases/words in **bold** indicate that the meaning of the phrase or the actual word is **essential** to the answer.

ecf/TE/cq (error carried forward) means that a wrong answer given in an earlier part of a question is used correctly in answer to a later part of the same question.

Candidates must make their meaning clear to the examiner to gain the mark. Make sure that the answer makes sense. Do not give credit for correct words/phrases which are put together in a meaningless manner. Answers must be in the correct context.

Quality of Written Communication

Questions which involve the writing of continuous prose will expect candidates to:

- write legibly, with accurate use of spelling, grammar and punctuation in order to make the meaning clear
- select and use a form and style of writing appropriate to purpose and to complex subject matter
- organise information clearly and coherently, using specialist vocabulary when appropriate.

Full marks will be awarded if the candidate has demonstrated the above abilities.

Questions where QWC is likely to be particularly important are indicated (QWC) in the mark scheme, but this does not preclude others.

Section A (multiple choice)

| Question Number | Correct Answer | Reject | Mark |
|-----------------|----------------|--------|------------|
| 1 | C | | (1) |

| Question Number | Correct Answer | Reject | Mark |
|-----------------|----------------|--------|------------|
| 2 | A | | (1) |

| Question Number | Correct Answer | Reject | Mark |
|-----------------|----------------|--------|------------|
| 3 | C | | (1) |

| Question Number | Correct Answer | Reject | Mark |
|-----------------|----------------|--------|------------|
| 4 | A | | (1) |

| Question Number | Correct Answer | Reject | Mark |
|-----------------|----------------|--------|------------|
| 5 | C | | (1) |

| Question Number | Correct Answer | Reject | Mark |
|-----------------|----------------|--------|------------|
| 6 | B | | (1) |

| Question Number | Correct Answer | Reject | Mark |
|-----------------|----------------|--------|------------|
| 7 | B | | (1) |

| Question Number | Correct Answer | Reject | Mark |
|-----------------|----------------|--------|------------|
| 8 | A | | (1) |

| Question Number | Correct Answer | Reject | Mark |
|-----------------|----------------|--------|------------|
| 9 | D | | (1) |

| Question Number | Correct Answer | Reject | Mark |
|-----------------|----------------|--------|------------|
| 10 | B | | (1) |

| Question Number | Correct Answer | Reject | Mark |
|-----------------|----------------|--------|------------|
| 11 | C | | (1) |

| Question Number | Correct Answer | Reject | Mark |
|-----------------|----------------|--------|------------|
| 12 | D | | (1) |

| Question Number | Correct Answer | Reject | Mark |
|-----------------|----------------|--------|------------|
| 13 | B | | (1) |

| Question Number | Correct Answer | Reject | Mark |
|-----------------|----------------|--------|------------|
| 14 | D | | (1) |

| Question Number | Correct Answer | Reject | Mark |
|-----------------|----------------|--------|------------|
| 15 | D | | (1) |

| Question Number | Correct Answer | Reject | Mark |
|-----------------|----------------|--------|------------|
| 16 | C | | (1) |

| Question Number | Correct Answer | Reject | Mark |
|-----------------|----------------|--------|------------|
| 17 | A | | (1) |

| Question Number | Correct Answer | Reject | Mark |
|-----------------|----------------|--------|------------|
| 18 | D | | (1) |

| Question Number | Correct Answer | Reject | Mark |
|-----------------|----------------|--------|------------|
| 19 | B | | (1) |

| Question Number | Correct Answer | Reject | Mark |
|-----------------|----------------|--------|------------|
| 20 | D | | (1) |

(Total for Section A = 20 marks)

Section B

| Question Number | Acceptable Answers | Reject | Mark |
|-----------------|--|--|------|
| 21(a)(i) | <p>use a colorimeter/colorimetry OR (quench the mixture with sodium hydrogencarbonate and) titrate with (sodium) thiosulfate solution (1)</p> <p>to monitor the (concentration of) iodine Conditional on first mark (1)</p> <p>ALLOW titrate with silver nitrate solution and to monitor the (concentration of) iodide ions (1)</p> <p>ALLOW measure the electrical conductivity and to monitor the (concentration of) H⁺/I⁻ ions (1)</p> | iodine 'clock' reaction dilatometer pH | (2) |

| Question Number | Acceptable Answers | Mark |
|-----------------|---|------|
| 21(a)(ii) | <p>Orders CH_3COCH_3 first order I_2 zero order H^+ first order</p> <p>all 3 correct (2) any 2 correct (1)</p> <p>Explanations CH_3COCH_3 –(initial) rate is (directly) proportional to $[\text{CH}_3\text{COCH}_3]$ / graph is straight line through the origin /increases linearly AND H^+ - (initial) rate is (directly) proportional to $[\text{H}^+]$/ graph is straight line through the origin /increases linearly</p> <p>ALLOW as $[\text{CH}_3\text{COCH}_3]$ doubles the rate doubles and as $[\text{H}^+]$ doubles the rate doubles (1)</p> <p>IGNORE gradient is constant IGNORE explanation linked to half life</p> <p>I_2 – (initial) rate does not change (as $[\text{I}_2]$ changes)/ graph is a horizontal line/ (initial) rate is independent of $[\text{I}_2]$ /line has zero gradient (1)</p> <p>IGNORE line has no gradient</p> | (4) |

| Question Number | Acceptable Answers | Reject | Mark |
|-----------------|---|---|------|
| 21(a)(iii) | $\text{rate} = k [\text{CH}_3\text{COCH}_3] [\text{H}^+]$ ALLOW $\text{rate} = k [\text{CH}_3\text{COCH}_3]^1 [\text{H}^+]^1 [\text{I}_2]^0$ R/r for rate Consequential on their orders in (a)(ii) IGNORE K for k IGNORE state symbols, even if incorrect | rate equation = no mention of rate = | (1) |

| Question Number | Acceptable Answers | Reject | Mark |
|-----------------|---|--|------|
| 21(a)(iv) | $k = \frac{8.80 \times 10^{-6}}{0.667 \times 0.667}$ $= 1.978 \times 10^{-5}$ (1) units $\text{dm}^3 \text{mol}^{-1} \text{s}^{-1}$ (1) ALLOW units in any order Both marks must be consequential on their rate equation IGNORE SF except 1SF | incorrect rounding eg 1.97×10^{-5} | (2) |

| Question Number | Acceptable Answers | Reject | Mark |
|-----------------|---|--|------|
| 21(a)(v) | First mark $(\text{CH}_3)_2\text{CO} + \text{H}^+ \rightarrow (\text{CH}_3)_2\text{C}^+\text{OH}$ (1) ALLOW $[(\text{CH}_3)_2\text{COH}]^+ / (\text{CH}_3)_2\text{COH}^+ / (\text{CH}_3)_2\text{CO}^+\text{H}$ Second mark (the rate-determining step) involves the species in the rate equation OR only propanone and H^+ ions are in the rate equation OR iodine is not in the rate equation so does not take part in (or before) the rds OR iodine is zero order so does not take part in (or before) the rds (1) IGNORE just 'reaction shown is consistent with rate equation' Both marks consequential on their rate equation | Any formula where H is not joined to O eg $\text{CH}_3\text{COCH}_4^+$ | (2) |

| Question Number | Acceptable Answers | Reject | Mark |
|-----------------|---|--------|------|
| 21(b)(i) | gradient = -19 600 K value (1) sign and units (1) ALLOW -18 600 to -20 600 Marks are stand alone IGNORE SF | | (2) |

| Question Number | Acceptable Answers | Mark |
|-----------------|--|------|
| 21(b)(ii) | $E_a = -8.31 \times \text{gradient}$ $= (+)163000 \text{ J mol}^{-1} / (+)163 \text{ kJ mol}^{-1}$ ALLOW (+)155000 to 171000 J mol ⁻¹ / 155 to 171 kJ mol ⁻¹ ALLOW TE from (b)(i) value (do not allow mark if value is negative) (1) value to 3sf and correct unit (1) | (2) |

(Total for Question 21 = 15 marks)



| Question Number | Acceptable Answers | Reject | Mark |
|-----------------|--|---|------|
| 22(a) | <p>First mark mix/add the reagents and filter OR react butanone/ketone with Brady's reagent/2,4-dinitrophenylhydrazine and filter OR filter the (yellow/orange) precipitate formed (1)</p> <p>Second mark recrystallize OR description of recrystallization ALLOW this mark even if the ppt is not filtered (1)</p> <p>Third mark measure the melting temperature (of derivative of butanone) and compare with data book /reference / literature value (1)</p> <p>Stand alone marks</p> | <p>Just 'crystallisation' if the precipitate has not been filtered</p> <p>Just 'characteristic melting temperature'</p> | (3) |

| Question Number | Acceptable Answers | Reject | Mark |
|-----------------|--|---|------|
| 22(b)(i) | <p>nucleophilic (1)</p> <p>addition (1)</p> <p>answers can be in any order IGNORE heterolytic</p> | <p>hydrolysis/reduction</p> <p>S_N1 or S_N2</p> | (2) |

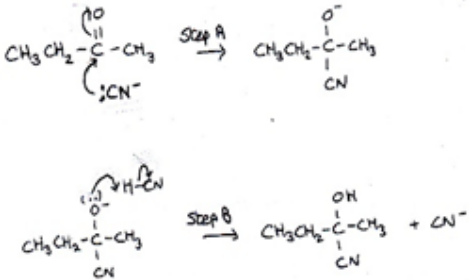
| Question Number | Acceptable Answers | Reject | Mark |
|-----------------|---|---|------|
| 22(b)(ii) | <p>Method 1 acid hydrolysis Name or formula of any strong acid eg (dilute) hydrochloric acid/ (dilute) sulfuric acid (1)</p> <p>IGNORE dilute acid / H⁺(aq)/ just 'H⁺'</p> <p>Boil/heat /reflux Conditional on acid as the only reagent ALLOW high temperature (1)</p> <p>Method 2 alkaline hydrolysis Sodium hydroxide solution/ dilute sodium hydroxide/ NaOH(aq) and boil/heat /reflux (1)</p> <p>then add dilute acid / H⁺(aq)/dilute hydrochloric acid/ dilute sulfuric acid (1)</p> | <p>Just 'concentrated sulfuric acid '</p> <p>Potassium dichromate(VI) and dilute sulfuric acid</p> <p>Just 'warm'</p> | (2) |

| Question Number | Acceptable Answers | Reject | Mark |
|-----------------|---|--|------|
| 22(b)(iii) |  <p>First mark both curly arrows on the first diagram arrow from C of CN⁻ to C of carbonyl and arrow from double bond to O ALLOW curly arrow from the - sign but not from the N (1) IGNORE correct dipoles</p> <p>Second mark lone pair on C of CN⁻ correct (1) IGNORE other lone pairs, even if incorrect</p> <p>Third mark both curly arrows on the third diagram arrow from O to H and from bond to C of CN ALLOW curly arrow to gap between C and N (1)</p> | <p>full charges on C / O incorrect dipole on C=O</p> <p>arrow directly to N of CN</p> | (3) |

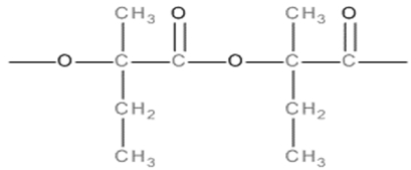
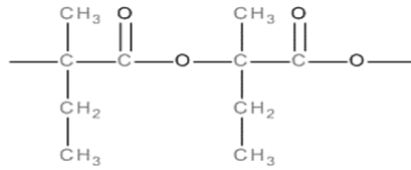
| Question Number | Acceptable Answers | Reject | Mark |
|-----------------|---|--|------|
| 22(b)(iv) | <p>First mark a racemic mixture/racemate forms OR equal amounts of the two optical isomers /enantiomers / D-L isomers / (+) and (-) isomers /R-S isomers (1)</p> <p>Second mark the molecule is (trigonal) planar around C=O /carbonyl group /reaction site (1)</p> <p>Third mark (equal probability of) the CN⁻ ion/nucleophile attacking (the C of C=O) from above or below/either side/both sides of (the plane) (1)</p> | For second mark only: mention of carbocation OR C=O/carbonyl carbon atom is planar OR intermediate is planar OR the molecule /butanone / ketone is planar | (3) |

| Question Number | Acceptable Answers | Reject | Mark |
|-----------------|--|--|------|
| 22(c) |  <p>OR</p>  <p>ALLOW any combination of displayed structure/ structural formula /skeletal formulae</p> <p>ester group correct ALLOW -COOC- (1)</p> <p>rest of polymer correct ALLOW C₂H₅ ALLOW more than 2 repeat units Conditional on ester group correct (1)</p> <p>IGNORE n and square brackets</p> |  <p>in polymer scores (0)</p> <p>more than 1 H missing from a bond</p> | (2) |

(Total for Question 22 = 15 marks)

| Question Number | Acceptable Answers | Reject | Mark |
|-----------------|---|--|------|
| 23(a)(i) | <p>ALLOW answers written on either set of dotted lines</p> <p>Weak: dissociates/ionizes to a small extent / partially / incompletely</p> <p>ALLOW does not ionise completely (1)</p> <p>Acid: proton donor ALLOW produces/forms /releases H⁺ ions / H₃O⁺ ions / oxonium ions / hydroxonium ions / hydronium ions</p> <p>ALLOW electron pair acceptor (1)</p> <p>IGNORE just 'accepts electrons'</p> <p>IGNORE contains H⁺ ions</p> <p>IGNORE reference to typical acid reactions</p> | 'not easily dissociated' / few H ⁺ ions | (2) |

| Question Number | Acceptable Answers | Reject | Mark |
|-----------------|--|--------------------|------|
| 23(a)(ii) | <p>(K_a =) $\frac{[\text{CHCl}_2\text{COO}^-][\text{H}^+]}{[\text{CHCl}_2\text{COOH}]}$</p> <p>OR [H₃O⁺] for [H⁺]</p> <p>ALLOW [CHCl₂CO₂⁻] / [CHCl₂CO₂H]</p> <p>IGNORE []_{eq} and state symbols, even if incorrect</p> | No /round brackets | (1) |

| Question Number | Acceptable Answers | Mark |
|-----------------|--|------|
| 23(a) (iii) | <p>weakest ethanoic acid chloroethanoic acid dichloroethanoic acid strongest trichloroethanoic acid</p> <p>OR correct formulae all four correct (1)</p> <p>Reason the weakest acid has the lowest K_a/ acid dissociation constant OR the weakest acid has the highest pK_a OR the strongest acid has the highest K_a/ acid dissociation constant OR the strongest acid has the lowest pK_a OR K_a increases/pK_a decreases from ethanoic acid to trichloroethanoic acid/ weakest to strongest acid ALLOW acid that dissociates least has the smallest K_a/highest pK_a ORA (1)</p> <p>IGNORE references to the effect of the chlorine atoms on K_a/stability of anion/strength of the O-H bond IGNORE references to pH</p> | (2) |

| Question Number | Acceptable Answers | Reject | Mark |
|-----------------|--|--------|------|
| 23(b) (i) | <p>IGNORE SF except 1 SF throughout</p> <p>FIRST CHECK THE FINAL ANSWER, IF answer pH = 2.88/2.9, award 2 marks IF pH = 2.89, decide which route has been followed and award 1 mark for routes 1 and 2 (rounding error) and 3 marks for route 3</p> <p>IF answer is not correct, award the following marks:</p> <p>Route 1 $[H^+] = \sqrt{K_a \times [CH_3COOH]}$ $= \sqrt{1.7 \times 10^{-5} \times 0.1}$ $= 1.3038 \times 10^{-3} \text{ (mol dm}^{-3}\text{)}$ (1)</p> <p>pH = 2.8848 (1) consequential on their $[H^+]$, provided pH is less than 7</p> <p>Route 2 $[H^+] = \sqrt{K_a \times [CH_3COOH]}$ pH = $\frac{1}{2} pK_a - \frac{1}{2} \log[CH_3COOH]$ (1) = 2.88 (1) consequential on their expression for pH</p> | | (4) |

| | | | |
|--|--|--|--|
| | <p>Assumption 1 $[H^+] = [CH_3COO^-]$ OR no H^+ from the (ionization of) water OR H^+ all comes from the acid (1)</p> <p>Assumption 2 Ionization of the (weak) acid is negligible / very small / insignificant OR $[CH_3COOH]_{initial} = [CH_3COOH]_{eqm}$ OR $[CH_3COOH]_{eqm} = 0.1 \text{ mol dm}^{-3}$ OR $[CH_3COOH]$ remains constant (1)</p> <p>Route 3 using $[CH_3COOH]_{eqm} = 0.1 - [H^+]$ (1)</p> <p>$[H^+] = 1.2954 \times 10^{-3} \text{ (mol dm}^{-3}\text{)}$ (1)</p> <p>pH = 2.8876 (1)</p> <p>Assumption $[H^+] = [CH_3COO^-]$ OR no H^+ from the (ionization of) water OR H^+ all comes from the acid (1)</p> <p>ALLOW $[HA]/[HX]/[\text{acid}]/[A^-]/[X^-]/[\text{base}]$ for formulae of acid and base</p> | <p>'no dissociation' OR 'partial'/incomplete' dissociation</p> | |
|--|--|--|--|

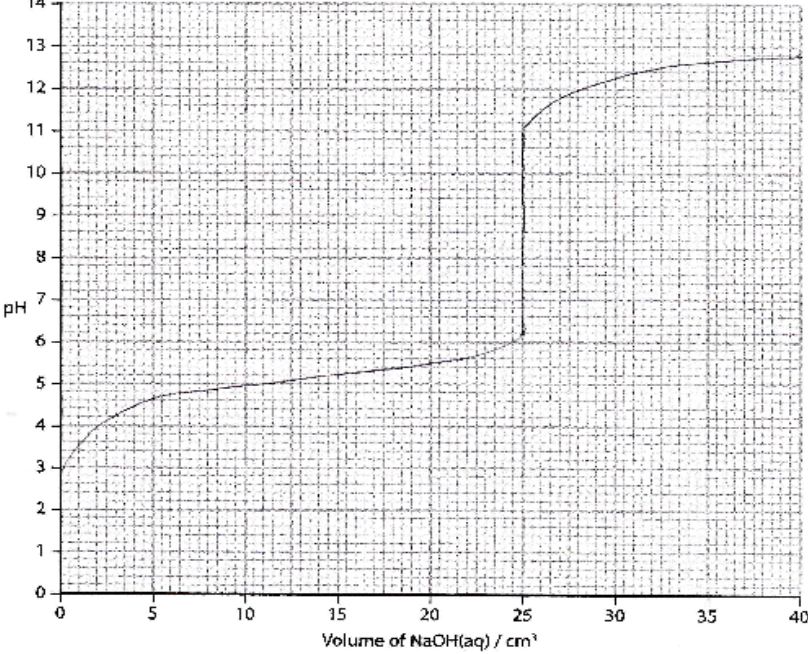
| Question Number | Acceptable Answers | Mark |
|-----------------|--|------|
| 23(b) (ii) |  <p data-bbox="435 932 1141 961">Graph starting at 2.9 (allow 2.8-3.0) or answer to (b)(i) (1)</p> <p data-bbox="435 993 1247 1022">Initial rise and buffering region to 25 cm³ (1)</p> <p data-bbox="435 1054 1247 1115">Vertical rise at 25 cm³, starting from pH 5.5-7 and ending at pH 10-12 (1)</p> <p data-bbox="435 1146 1247 1207">Finishing (asymptotically) between pH 12-13 inclusive and reaching at least 38 cm³ (1)</p> <p data-bbox="435 1239 1252 1356">Note: If graph is sketched as if ethanoic acid is added to NaOH, the only mark available is the vertical jump down at 25 cm³, starting from 10-12 and ending at 5.5-7</p> | (4) |

| Question Number | Acceptable Answers | Reject | Mark |
|-----------------|--|---|------|
| 23(b)(iii) | <p>any correct indicator that has the complete pH range within the vertical jump on their titration curve</p> <p>Note: expected indicators numbers 14 to 17 from Data Booklet ie phenol red (6.8-8.4) thymol blue ((base)) (8.0-9.6) phenolphthalein (8.2-10.0) thymolphthalein (8.3-10.6)</p> <p>ALLOW bromothymol blue (6.0-7.6) if their vertical range starts at or below 6.0 (1)</p> <p>Justification – conditional on a correct indicator</p> <p>pH range (of indicator) lies (completely) within the vertical jump (on the titration curve)</p> <p>OR</p> <p>indicator will change colour in the vertical section of the graph</p> <p>OR</p> <p>pH range of indicator and pH range of vertical section of the graph stated as long as they overlap</p> <p>ALLOW</p> <p>$pK_{in} (\pm 1)$ is in the mid-point of the vertical jump</p> <p>ALLOW</p> <p>pK_{in} is nearest to the pH at the end/equivalence point</p> <p>ALLOW</p> <p>indicator will change colour at the end/equivalence point (1)</p> <p>IGNORE</p> <p>(because it is a) titration of a weak acid with strong alkali</p> | <p>If no titration curve (0)</p> <p>litmus/azolitmin</p> <p>universal indicator</p> | (2) |

Section C

| Question Number | Acceptable Answers | Mark |
|-----------------|--|------|
| 24(a)(i) | $(K_c =) \frac{[\text{CH}_3\text{COOCH}_2\text{CH}_3][\text{H}_2\text{O}]}{[\text{CH}_3\text{COOH}][\text{CH}_3\text{CH}_2\text{OH}]}$ <p>ALLOW C₂H₅OH for ethanol ALLOW CH₃CO₂H for ethanoic acid ALLOW CH₃CO₂CH₂CH₃ / CH₃CO₂C₂H₅ / CH₃COOC₂H₅ for ethyl ethanoate</p> <p>IGNORE state symbols, even if incorrect</p> | (1) |

| Question Number | Acceptable Answers | Mark |
|-----------------|--|------|
| 24(a)(ii) | <p>Stand alone marks</p> <p>the enthalpy change is (very) small/close to zero OR reaction is slightly exothermic (1)</p> <p>therefore, (the magnitude of) $\Delta S_{\text{surroundings}}$ (= $-\Delta H/T$) changes very little (1)</p> <p>IGNORE $\Delta S_{\text{surroundings}}$ is positive/small/less/decreases</p> <p>ΔS_{total} / K_c changes very little (provided there is no change of state) (1)</p> <p>Ignore references to ΔS_{system}</p> | (3) |

| Question Number | Acceptable Answers | Reject | Mark |
|-----------------|---|-----------|------|
| 24(a) * (iii) | <p>If final answer is 5.1143/5.1, award 6 marks</p> <p>If not, award marks as follows</p> <p>Marks 1 and 2 If mol CH₃COOH left = 0.040 (2) Otherwise: mol NaOH/total mol of acid = 45.0 x 1.00/1000 = 0.045 (1)</p> <p>mol CH₃COOH left = mol NaOH/total mol of acid - 0.005 (1)</p> <p>Marks 3 to 6 mol CH₃CH₂OH at eqm = 0.140 (1) mol CH₃COOCH₂CH₃ at eqm = 0.080 (1) mol H₂O at eqm = 0.358 (1)</p> $K_c = \frac{0.080 \times 0.358}{\frac{V}{V} \times \frac{0.040 \times 0.140}{V}}$ <p>= 5.1143 (1)</p> <p>consequential on their expression for K_c shown/used here and their numbers of moles</p> <p>ALLOW K_c expression without the Vs but do not allow this sixth mark if the moles are divided by a specific volume e.g. 45 to calculate the concentration</p> <p>IGNORE SF except 1 SF in final answer</p> | any units | (6) |

| Question Number | Acceptable Answers | Mark |
|-----------------|--|------|
| 24(b)(i) | <p>EITHER</p> $\begin{array}{l} \text{C : H : O} \\ \text{mol } \frac{64.9}{12} : \frac{13.5}{1} : \frac{21.6}{16} \\ = 5.408 : 13.5 : 1.35 \\ = 4.006 : 10 : 1 \\ = 4 : 10 : 1 \end{array}$ <p style="text-align: right;">(1)</p> <p>use of 74 to show molecular formula is C₄H₁₀O eg M_r is (4x12)+(10x1)+16 =74</p> <p style="text-align: right;">(1)</p> <p>OR</p> <p>C atoms = $\frac{64.9 \times 74}{100 \times 12} = 4$</p> <p>H atoms = $\frac{13.5 \times 74}{100 \times 1} = 10$</p> <p>O atoms = $\frac{21.6 \times 74}{100 \times 16} = 1$</p> <p>This may be done in 2 steps eg C $\frac{64.9 \times 74}{100} = 48$ $\frac{48}{12} = 4$</p> <p>All 3 correct scores 2 Any 2 correct scores 1</p> <p>OR</p> <p>% C = $\frac{48 \times 100}{74} = 64.9$</p> <p>% H = $\frac{10 \times 100}{74} = 13.5$</p> <p>% O = $\frac{16 \times 100}{74} = 21.6$</p> <p>All 3 correct scores (2) Any 2 correct scores (1)</p> | (2) |

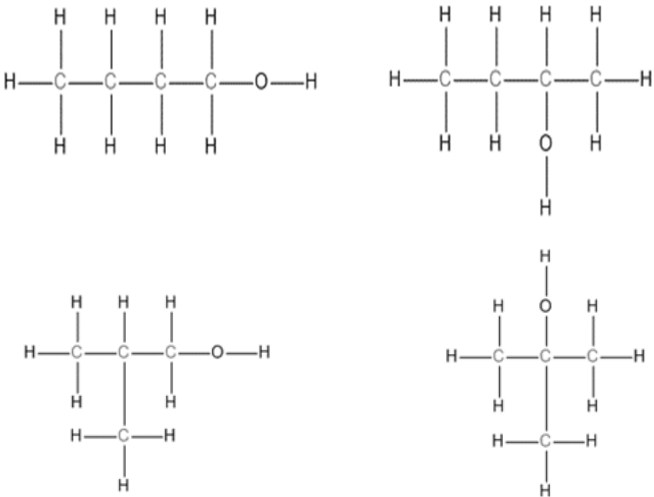
| Question Number | Acceptable Answers | Reject | Mark |
|-----------------|---|--|------|
| 24(b)(ii) |  <p>Alcohols can be in any order</p> <p>ALLOW OH</p> <p>All FOUR correct scores (2) Two or three correct scores (1)</p> <p>ALLOW all four skeletal/structural/mixture of displayed and structural (1)</p> <p>IGNORE optical isomers of butan-2-ol</p> | <p>molecular formula</p> <p>OH-C.. on left of structure once only</p> <p>more than 1 H missing from a bond</p> | (2) |

| Question Number | Acceptable Answers | Mark |
|-----------------|--|------|
| 24(b)(iii) | <p>$\text{CH}_3\text{C}^+\text{HOH}/[\text{CH}_3\text{CHOH}]^+$ ALLOW $\text{CH}_3\text{CHOH}^+/\text{CH}_3\text{CHOH}$ (1)</p> <p>$^+\text{CH}_2\text{CH}_2\text{OH}/[\text{CH}_2\text{CH}_2\text{OH}]^+$ ALLOW $\text{CH}_2\text{CH}_2\text{OH}^+/\text{C}_2\text{H}_4\text{OH}^+$ (1)</p> <p>Only penalise missing + once.</p> <p>Note: If no structures given, allow 1 mark for $\text{C}_2\text{H}_5\text{O}^+$ but do not award the mark if C_3H_9^+ is given as well</p> | (2) |

| Question Number | Acceptable Answers | Mark |
|-----------------|---|------|
| 24(b)(iv) | <p>butan-1-ol and butan-2-ol OR structures OR identified by number from (b)(ii)</p> | (1) |

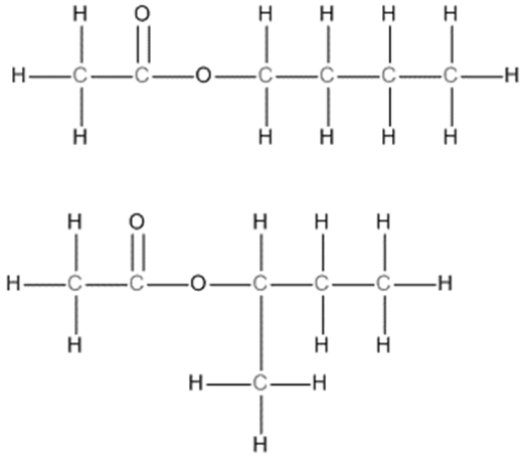
| Question Number | Acceptable Answers | Reject | Mark |
|-----------------|--|--|------|
| 24(b)(v) |  <p>ALLOW any unambiguous structures e.g. displayed, structural, skeletal or a combination of these, TE from (b)(iv)</p> | <p>C₄H₉</p> <p>structures with more than 1 H missing from a bond</p> | (1) |

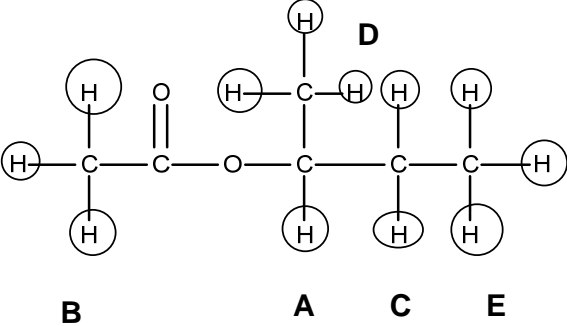
| Question Number | Acceptable Answers | Mark |
|-----------------|---|------------|
| 24(b)(vi) | <p>No structure is given or an ester formed from a different alcohol eg propanol scores (0)</p> <p>First mark - structure Correct structure (1)</p>  <p style="text-align: center;">B A C E</p> <p>Protons can be labelled or circled and labelled</p> <p>ALLOW any unambiguous structure eg displayed, structural, skeletal or a combination of these.</p> <p>Five peaks correct scores (2) Three or four peaks correct scores (1)</p> <p>Splitting Any two correct scores (2) No splitting for peak B as there is no H attached to the adjacent carbon OR application of the (n+1) rule to peak A (which is a multiplet/sextet) OR application of the (n+1) rule to peak C (which is a multiplet/quintet) OR application of the (n+1) rule to peak D (which is a doublet) OR application of the (n+1) rule to peak E (which is a triplet)</p> <p>If ester has been formed from butan-1-ol, maximum 2 marks for identification of peaks B, C and E and 2 marks for correct splitting in any two of peaks B, C and E</p> <p>If ester has been formed from either of the other 2 alcohols, 1 mark for identification of peak B, 1 mark for explaining why there is no splitting in peak B</p> | (5) |

(Total for Question 24 = 23 marks)

Pearson Education Limited. Registered company number 872828
with its registered office at 80 Strand, London WC2R 0RL