

Centre Number	Candidate Number	Name
---------------	------------------	------

UNIVERSITY OF CAMBRIDGE INTERNATIONAL EXAMINATIONS  
General Certificate of Education  
Advanced Level

**BIOLOGY** **9700/06**

Paper 6 Options May/June 2004

**1 hour**

No Additional Materials are required

**READ THESE INSTRUCTIONS FIRST**

Write your Centre Number, Candidate Number and Name in the spaces at the top of this page and on all separate answer paper used.  
Write in dark blue or black pen.  
You may use a soft pencil for any diagrams, graphs or rough working.  
Do not use staples, paper clips, highlighters, glue or correction fluid.

Answer the questions set on **one** of the options only.  
Answer **all** four questions from your chosen option only.

Within your chosen option, write your answers to the Questions in the spaces provided on the Question Paper. At the end of the examination, **enter the number of the option you have answered in the grid below.**

**INFORMATION FOR CANDIDATES**

The number of marks is given in brackets [ ] at the end of each question or part question.  
The options are:  
1 – Mammalian Physiology (page 2)  
2 – Microbiology and Biotechnology (page 10)  
3 – Growth, Development and Reproduction (page 19)  
4 – Applications of Genetics (page 28)

If you have been given a label, look at the details. If any details are incorrect or missing, please fill in your correct details in the space given at the top of this page.

Stick your personal label here, if provided.

<b>OPTION ANSWERED</b>	
<b>FOR EXAMINER'S USE</b>	
<b>1</b>	
<b>2</b>	
<b>3</b>	
<b>4</b>	
<b>TOTAL</b>	

OPTION 1 – MAMMALIAN PHYSIOLOGY

Examiner's Use

1 Fig.1.1 is a diagram drawn from a photomicrograph of a section through the stomach wall.

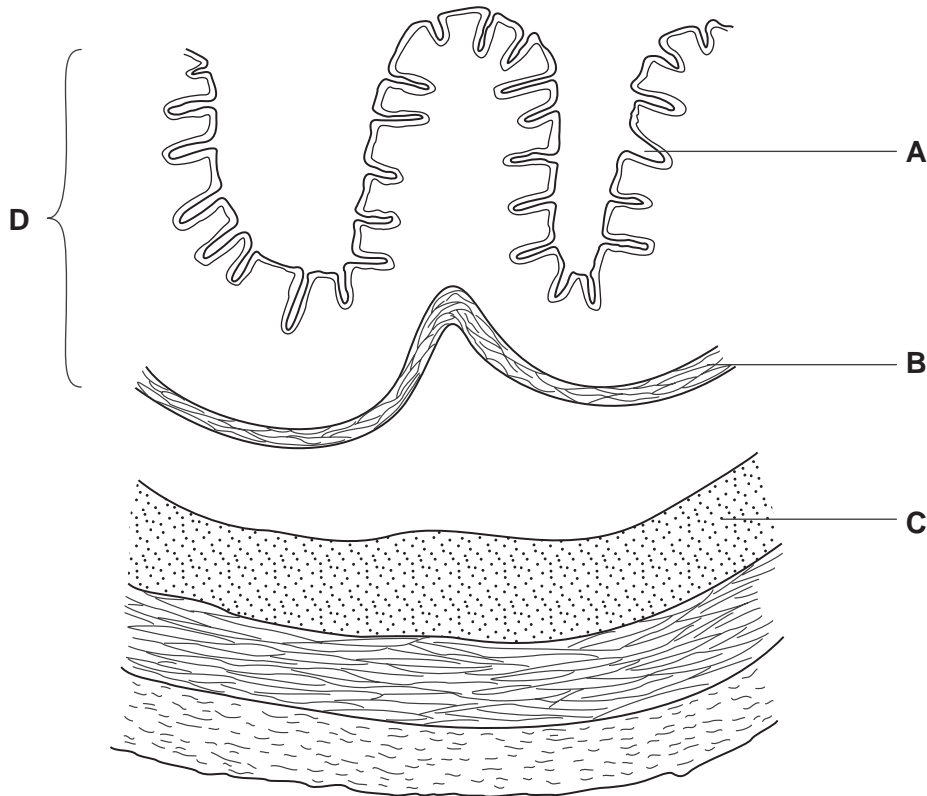

Fig. 1.1

(a) Name A to D.

A .....

B .....

C .....

D .....

[2]

(b) Pepsin is an enzyme which acts in the stomach.

(i) Describe how pepsin is secreted and activated.

.....

.....

.....[2]

(ii) Describe the function of pepsin.

.....

.....

.....

..... [3]

- (c) The secretion of hydrochloric acid by the stomach wall is controlled by the hormones gastrin and somatostatin.

In an investigation into the effect of these hormones, samples of stomach tissue were exposed to three treatments:

- gastrin alone
- gastrin plus somatostatin
- no hormones

The rate of acid secretion, measured as the amount of hydrogen ions secreted per hour, was recorded over a period of 180 minutes. The results are shown in Fig. 1.2.

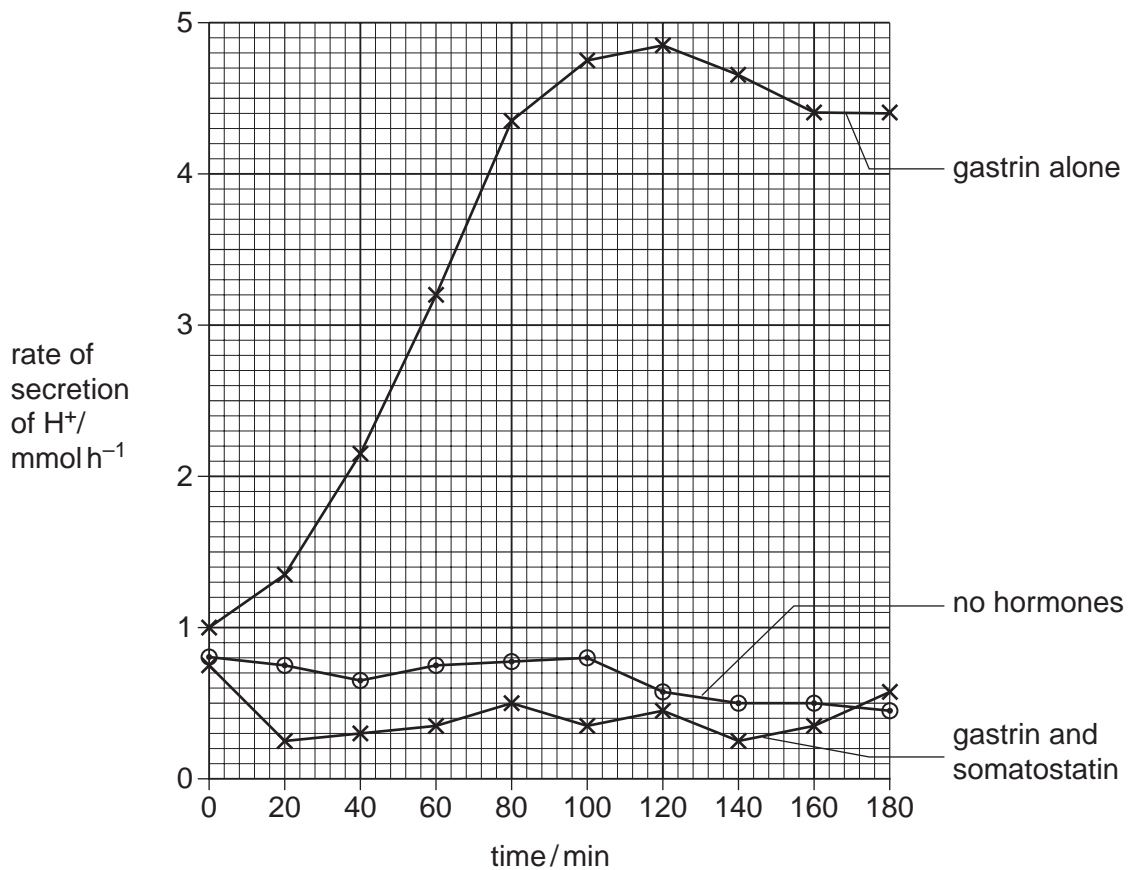

Fig. 1.2

(i) With reference to Fig. 1.2, describe the effect of gastrin on the secretion of hydrochloric acid.

.....  
.....  
.....  
.....  
.....[3]

(ii) One type of cell in the gastric pit reacts to the presence of acid by releasing somatostatin. With reference to Fig. 1.2, and to your knowledge of the principles of homeostasis, explain how this could help to control the acidity of the stomach contents.

.....  
.....  
.....  
.....  
.....[3]

(iii) The stomach tissue used in this investigation had not been exposed to food in the previous 24 hours. Explain why this was necessary.

.....  
.....  
.....  
.....[2]

[Total : 15]

- 2 (a) Fig. 2.1 shows a lumbar vertebra from a mammal.

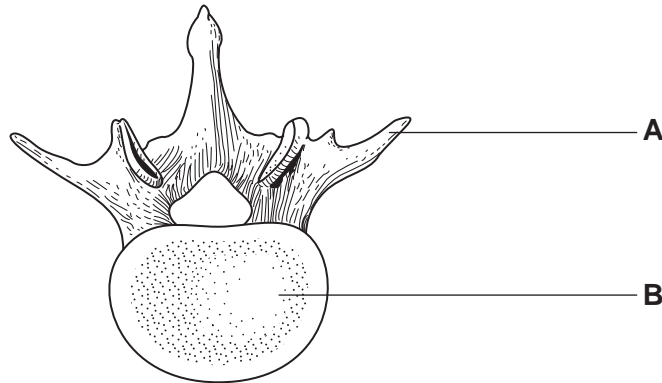

**Fig. 2.1**

Outline the functions of the parts of the vertebra labelled **A** and **B**.

- A** .....
- .....
- B** .....
- .....[2]

- (b) Osteoporosis is a disease which is characterised by a reduced density of bone. One area of the skeleton that is greatly weakened by osteoporosis is the upper end of the femur, which becomes more likely to fracture.

Table 2.1 shows the results of a study into the incidence of fractures of the upper end of the femur in men and women of different ages.

**Table 2.1**

age range	number of fractures per 10 <sup>6</sup> people	
	men	women
20–29	9	1
30–39	9	3
40–49	10	5
50–59	12	21
60–69	48	98
70–79	101	222
80–89	298	599

With reference to Table 2.1,

- (i) calculate the percentage increase for women in the number of fractures between the ages of 40–49 and 50–59. Show your working;

..... [2]

- (ii) compare the changes in the risk of fracture in men and women as both get older;

.....

.....

.....

..... [2]

- (iii) explain the changes that you have described in (i) and (ii).

.....

.....

.....

.....

..... [2]

[Total : 8]

3 (a) Fig. 3.1 shows how excess amino acids are converted to urea in the liver.

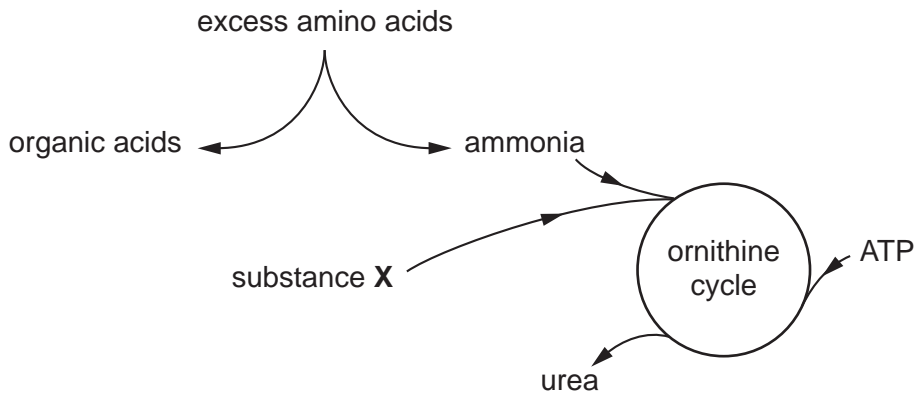

Fig. 3.1

(i) Name substance X.

.....[1]

(ii) Name the blood vessel in which the urea that is formed leaves the liver, and outline how the urea is excreted from the body.

*blood vessel* .....

*how the urea is excreted* .....

.....

.....

.....[3]

(iii) Aquatic animals are able to excrete ammonia directly into the water surrounding them. With reference to Fig. 3.1, suggest why this is advantageous compared with the excretion of urea.

.....

.....

.....[2]

(b) Another metabolic reaction which takes place in the liver and which involves amino acids is transamination. Describe transamination and explain why it takes place.

.....

.....

.....

.....[3]

[Total : 9]



- 4 (a) Fig. 4.1 shows a vertical section through a human eye. The eye is focused on a distant object in low intensity (dim) light.

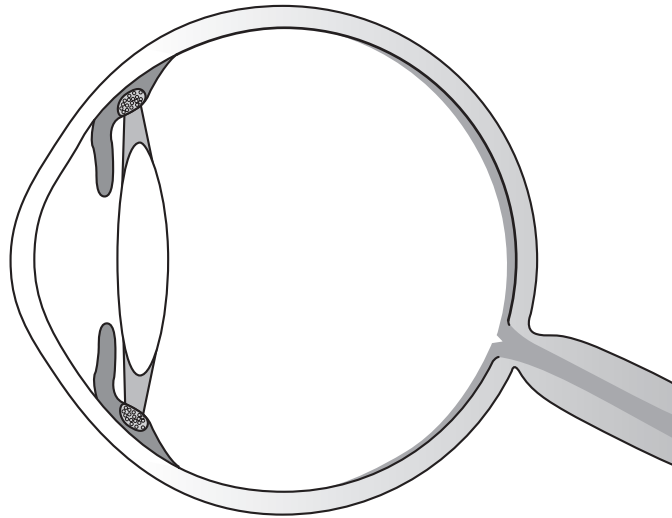

Fig. 4.1

Describe how the following responses of the eye would be brought about:

- (i) the decrease in size of the pupil when light intensity increases;

.....  
.....  
.....  
.....  
.....  
.....  
.....  
.....[4]

- (ii) the increase in curvature of the lens when focusing on a nearby object.

.....  
.....  
.....  
.....  
.....  
.....  
.....[4]

[Total : 8]

[Turn over

**OPTION 2 – MICROBIOLOGY AND BIOTECHNOLOGY**

1 (a) Fig. 1.1 shows the structure of an isolated virus.

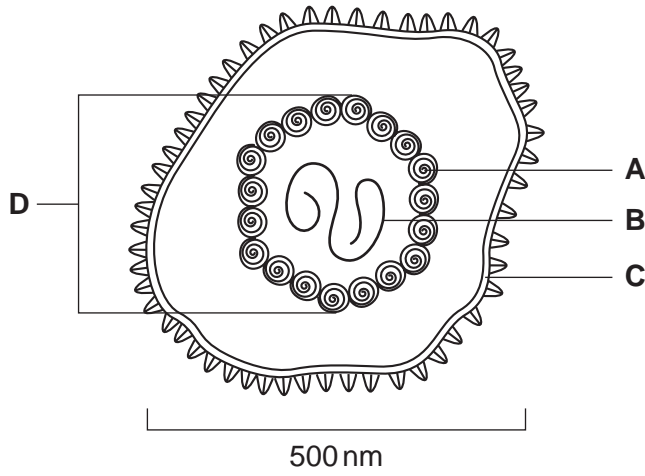

**Fig. 1.1**

(i) Name A to D.

- A .....
- B .....
- C .....
- D .....

[2]

(ii) Calculate the magnification of Fig 1.1. Show your working.

magnification ..... [2]

(b) State two characteristics that are used to distinguish viruses from prokaryotae and fungi.

- 1. ....
- 2. ....[2]

- (c) Describe precisely how viruses multiply in the human body.

.....

.....

.....

.....

.....

.....

.....

.....[3]

- (d) Fig.1.2 shows the number of HIV/AIDS cases diagnosed in a European country from 1983 to 1997.

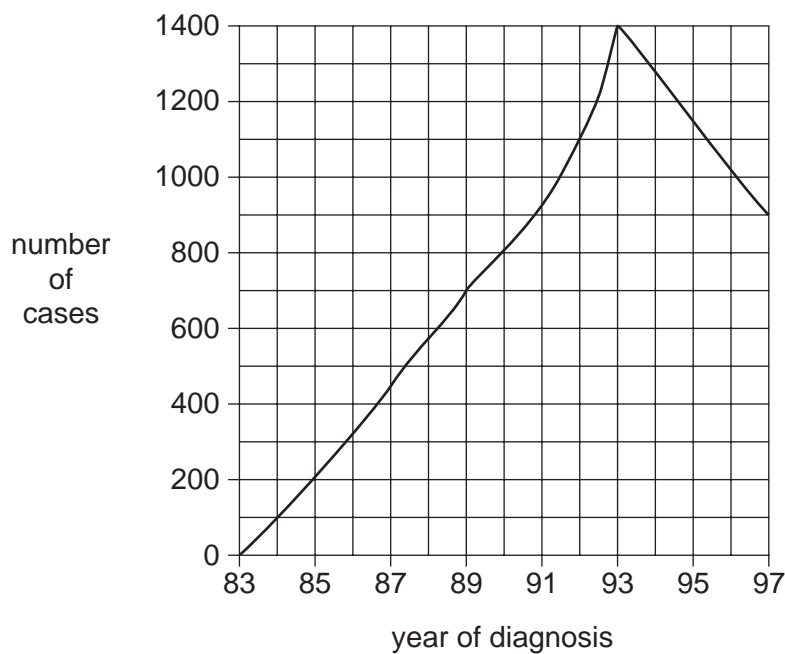

**Fig.1.2**

- (i) Calculate for the period of 1989 to 1993, the mean rate of increase in HIV/AIDS cases. Show your working.

.....[2]

**(ii)** State two methods of transmission of HIV/AIDS, other than by sexual contact.

1. ....

.....

2. ....

.....[2]

**(iii)** Suggest two explanations for the trend in the incidence of HIV/AIDS from 1993 to 1997.

1. ....

.....

2. ....

.....[2]

[Total : 15]

- 2 Mycoprotein, an alternative to meat, is produced by growing the fungus, *Fusarium graminearum*, in an air-lift fermenter, similar to the one shown in Fig. 2.1.

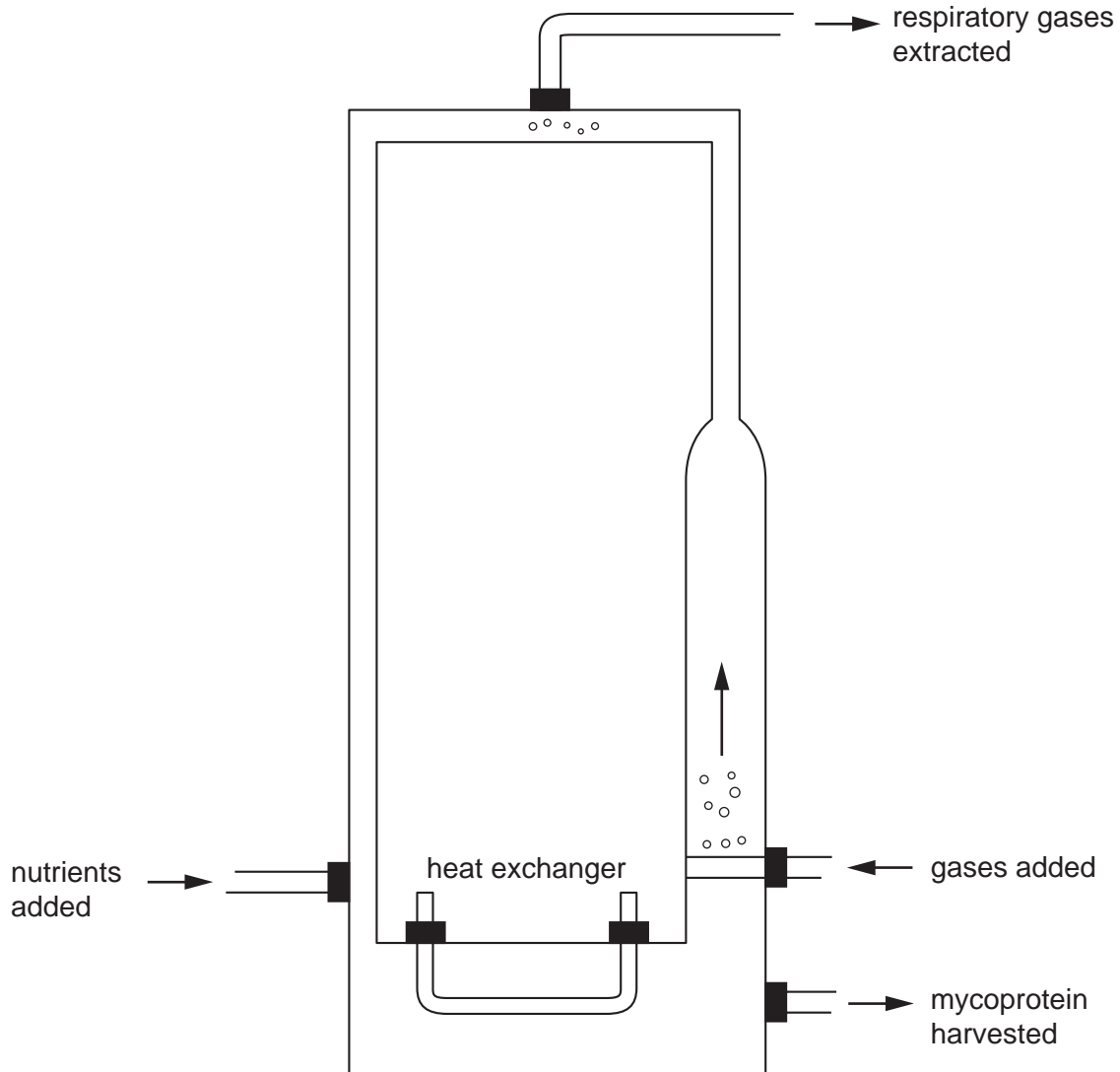

Fig. 2.1

- (a) (i) With reference to Fig. 2.1, explain how an air-lift fermenter works.

.....

.....

.....

.....

.....

.....[3]

(ii) List three nutrient growth requirements of *Fusarium*.

- 1. ....
- 2. ....
- 3. ....[3]

(b) Describe two ways in which *Fusarium* must be processed **after** fermentation to make it acceptable as a human food product.

- 1. ....  
.....
- 2. ....  
.....[2]

[Total : 8]

3 (a) Describe the roles of barley and yeast enzymes in beer production.

.....  
 .....  
 .....  
 .....  
 .....  
 .....[4]

(b) Most beers contain starch. Recently, 'light' beers of low energy content have become more popular. Light beers have a low starch content. This is achieved by the addition of immobilised fungal amylase after the mashing process.

(i) Explain the advantage of using immobilised enzymes in this process.

.....  
 .....  
 .....  
 .....  
 .....[4]

(ii) The effect of two different types of immobilised fungal amylase on the hydrolysis of starch is shown in Table 3.1. In these reactions starch is not a limiting factor.

**Table 3.1**

time / h	mass of maltose produced / g	
	$\alpha$ amylase	$\beta$ amylase
0	0	0
1	0.05	0.05
2	0.20	0.10
3	0.60	0.20

With reference to Table 3.1, explain which of these enzymes would be used in the production of light beers with a low starch content.

.....  
 .....  
 .....[2]

4 (a) Diabetes can be controlled by daily injections of insulin. The insulin used to be produced from pigs. Genetically engineered (transgenic) microorganisms can now be used to produce human insulin.

(i) Explain what is meant by a *genetically engineered microorganism*.

.....  
 .....  
 .....[2]

(ii) State two problems that are avoided by using insulin produced by genetically engineered microorganisms rather than insulin from pigs.

1 .....  
 .....  
 2.....[2]

(b) Restriction enzymes can be used to cut DNA at specific sites. Genes such as the gene for insulin, can be cut from the chromosome of one species and as a result of ligation joined to the chromosome of another species forming recombinant (hybrid) DNA.

Fig. 4.1 shows two chromosomes from different species. The specific restriction enzyme sites (R1, R2, and R3) are shown.

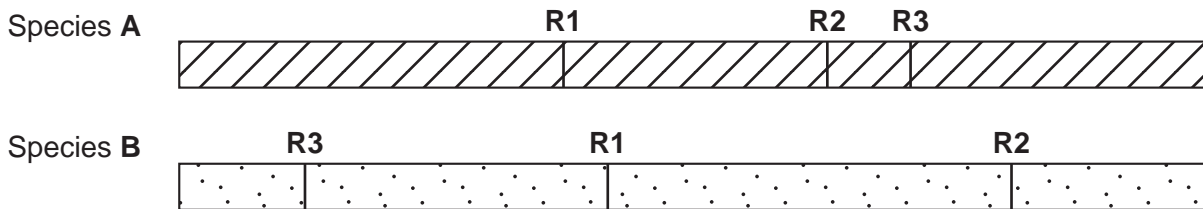

Fig. 4.1



Both chromosomes were cut at restriction site **R1**. The fragments were mixed and allowed to join to form recombinant (hybrid) DNA.

Sketch **all** the possible ways in which the fragments could join in the space below.

[3]

[Total : 7]



**OPTION 3 - GROWTH, DEVELOPMENT AND REPRODUCTION**

1 (a) Explain why growing plantlets from a callus in tissue culture results in a clone.

.....

.....

.....

.....[3]

(b) Equal masses of tobacco plant callus were cultured for four weeks on media containing different concentrations of two plant growth regulators: auxin and cytokinin. The results are shown in Table 1.1.

**Table 1.1**

treatment	concentration of plant growth regulators / mg dm <sup>-3</sup>		effect of plant growth regulators on callus growth
	auxin	cytokinin	
<b>A</b>	2.00	0.00	little or no growth
<b>B</b>	2.00	0.02	growth of roots
<b>C</b>	2.00	0.20	increased growth of callus with no differentiation
<b>D</b>	2.00	0.50	growth of shoots
<b>E</b>	0.00	0.20	little or no growth

With reference to Table 1.1,

(i) describe the effects of auxin and cytokinin on callus growth;

.....

.....

.....

.....

.....[3]

- (ii) suggest what treatment should be given to the shoots developed from callus in treatment D to turn them into plantlets.

.....

.....

.....

.....[2]

- (c) One of the difficulties of culturing callus is surface sterilising the piece of plant tissue (explant) to be used, especially when samples are being taken from the wild in tropical countries.

In Trinidad, plant tissue samples were taken at three different times of the year and placed on a medium containing no fungicide or antibiotic. Two different sampling methods were used:

- \* discs cut from leaves wiped with bleach;
- \* stem tissues extracted with a sterile hypodermic syringe.

The results of culturing the explants are shown in Table 1.2.

**Table 1.2**

explant	time of year	number of explants	number of cultured explants with <b>no</b> fungal or bacterial contamination	percentage of cultured explants with <b>no</b> fungal or bacterial contamination
leaf disc	April	153	12	8
	August	322	16	5
	January	332	30	9
stem tissue	April	194	116	60
	August	191	122	64
	January	211	156	

With reference to Table 1.2,

- (i) calculate the percentage of cultured **stem** tissue explants with **no** fungal or bacterial contamination in January. Write your answer in the appropriate box in the table;  
Show your working in the space below.

(ii) compare the effect of the different methods of taking tissue samples and the time of year on fungal and bacterial contamination of the cultured explants.

.....  
.....  
.....  
..... [3]

(d) Suggest how the number of contaminated samples could be reduced when collecting explants from the wild.

.....  
.....  
..... [2]

[Total : 15]

- 2 The fertility of a large group of European women aged between 19 and 39 was investigated. All were trying to become pregnant. Neither the women, nor their partners, had any history of fertility problems.

The probability of pregnancy following intercourse on a given day relative to the day of ovulation (day 0) was calculated for three different age groups of women. Their partners were either the same age or five years older.

The results of the investigation are shown in Fig. 2.1.

Key: — partner same age    - - - - - partner 5 years older

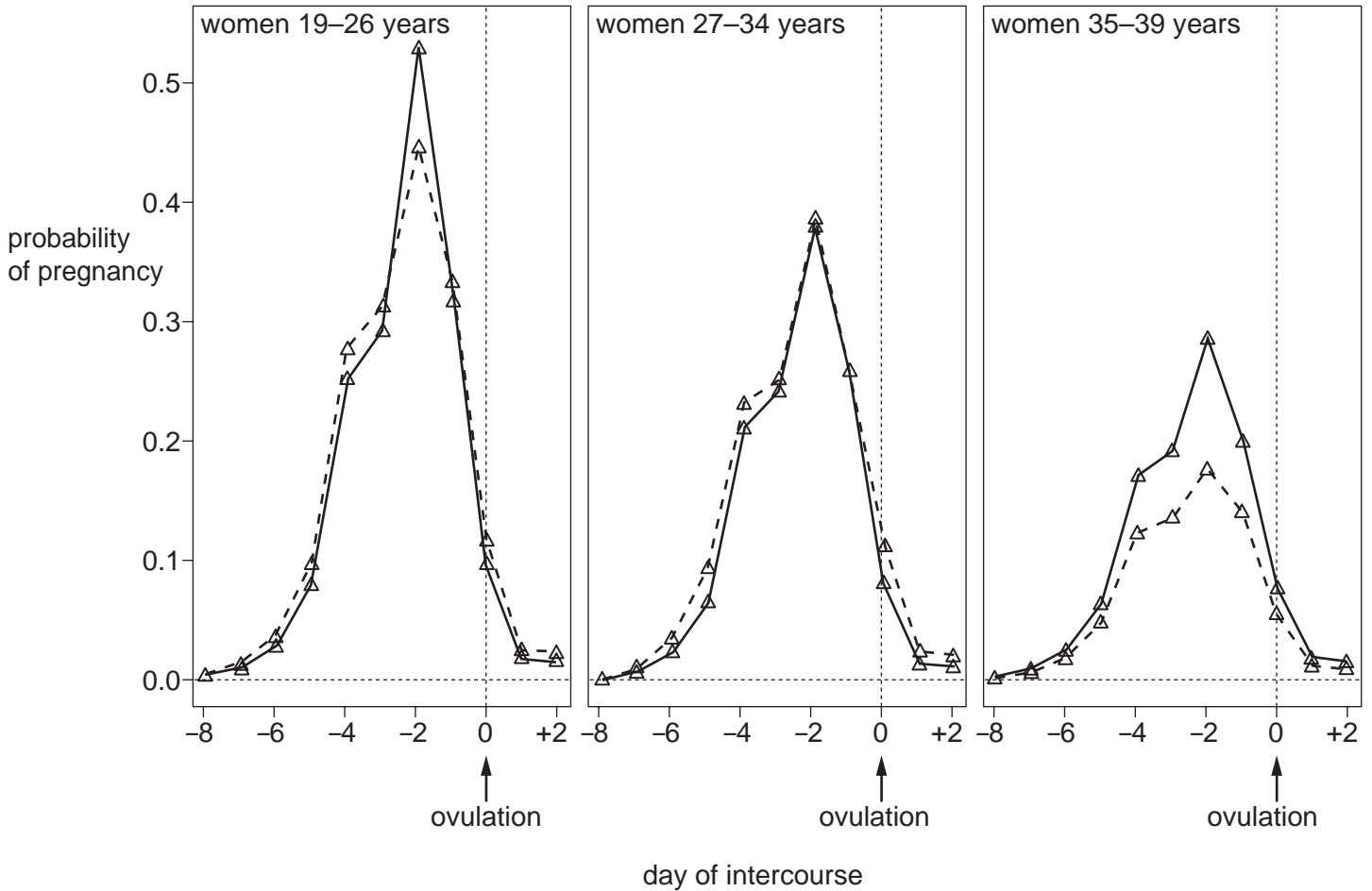

Fig. 2.1

- (a) With reference to Fig. 2.1, describe the effect on the probability of pregnancy of  
(i) women's age;

.....

.....

.....

..... [3]

(ii) women having partners five years older than themselves;

.....  
.....  
..... [2]

(iii) day of intercourse relative to ovulation.

.....  
.....  
..... [2]

(b) Explain why intercourse two days before ovulation leads to the greatest probability of pregnancy in all age groups of women.

.....  
.....  
.....  
..... [3]

[Total : 10]

3 (a) Fig. 3.1 is a diagram of a transverse section of the anther of a stamen.

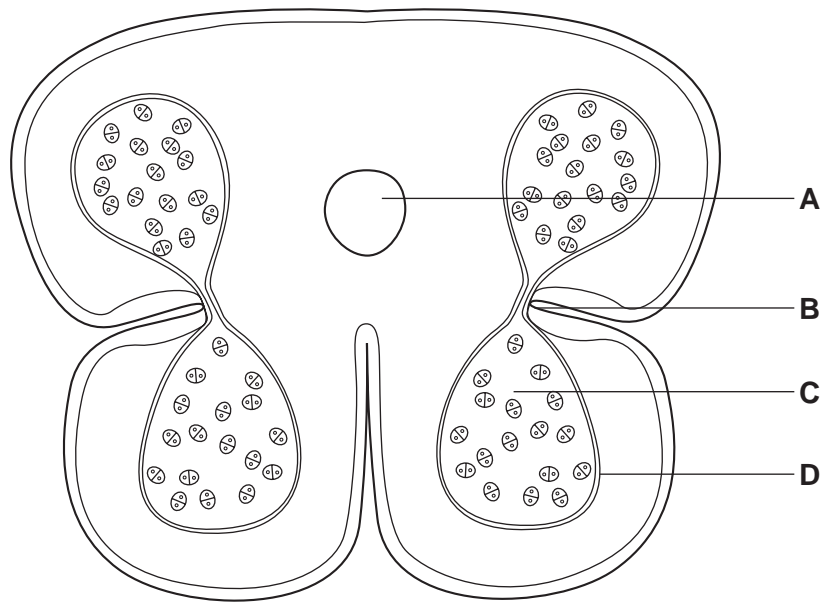

Fig. 3.1

Name A to D.

- A .....
- B .....
- C .....
- D .....

[2]

(b) Describe pollen formation.

.....  
 .....  
 .....  
 .....  
 .....  
 .....  
 .....[4]



- (c) Complete the outline drawing of a section of an anther shown in Fig. 3.2 to show what happens to an anther to allow pollen dispersal.

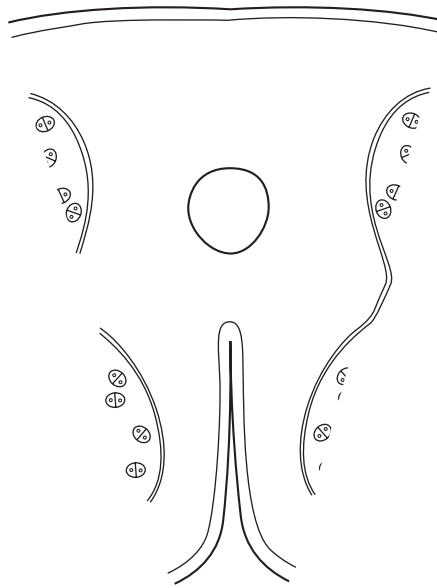

**Fig. 3.2**

[2]

[Total : 8]

- 4 (a) Fig. 4.1 shows the mean percentage of eventual mature height reached at different ages by boys and girls.

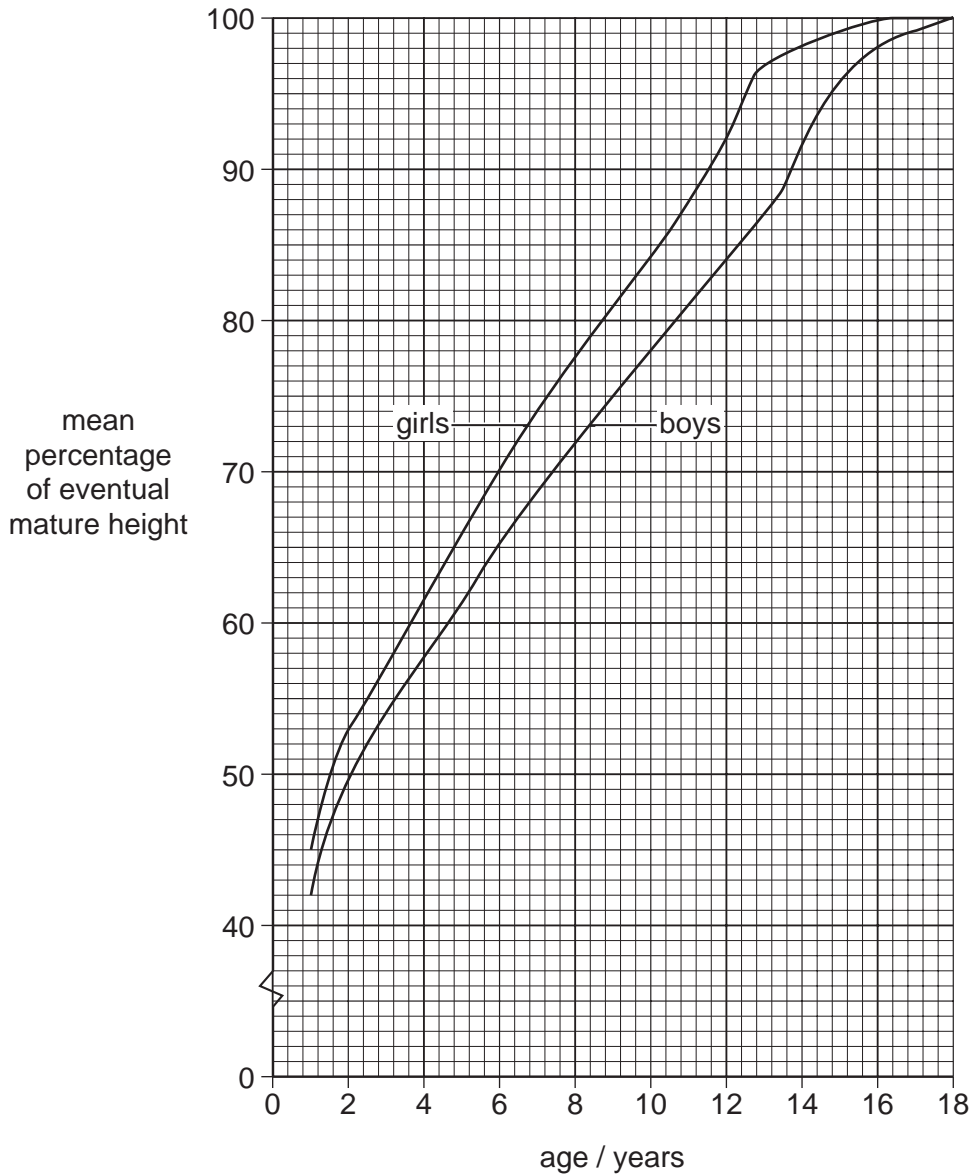

Fig. 4.1

With reference to Fig. 4.1,

- (i) explain how such data were obtained;

.....

.....

.....

..... [3]

(ii) compare the data for boys and girls;

.....  
.....  
..... [2]

(iii) suggest **one** use for such data.

.....  
.....  
..... [2]

[Total : 7]

## OPTION 4 – APPLICATIONS OF GENETICS

- 1 (a) Explain why growing plantlets from a callus in tissue culture results in a clone.

.....

.....

.....

.....[3]

- (b) Equal masses of tobacco plant callus were cultured for four weeks on media containing different concentrations of two plant growth regulators: auxin and cytokinin. The results are shown in Table 1.1.

Table 1.1

treatment	concentration of plant growth regulators / mg dm <sup>-3</sup>		effect of plant growth regulators on callus growth
	auxin	cytokinin	
<b>A</b>	2.00	0.00	little or no growth
<b>B</b>	2.00	0.02	growth of roots
<b>C</b>	2.00	0.20	increased growth of callus with no differentiation
<b>D</b>	2.00	0.50	growth of shoots
<b>E</b>	0.00	0.20	little or no growth

With reference to Table 1.1,

- (i) describe the effects of auxin and cytokinin on callus growth;

.....

.....

.....

.....

.....[3]

(ii) suggest what treatment should be given to the shoots developed from callus in treatment **D** to turn them into plantlets.

.....

.....

.....

.....[2]

(c) One of the difficulties of culturing callus is surface sterilising the piece of plant tissue (explant) to be used, especially when samples are being taken from the wild in tropical countries.

In Trinidad, plant tissue samples were taken at three different times of the year and placed on a medium containing no fungicide or antibiotic. Two different sampling methods were used:

- \* discs cut from leaves wiped with bleach;
- \* stem tissues extracted with a sterile hypodermic syringe.

The results of culturing the explants are shown in Table 1.2 on the next page.

**Table 1.2**

explant	time of year	number of explants	number of cultured explants with <b>no</b> fungal or bacterial contamination	percentage of cultured explants with <b>no</b> fungal or bacterial contamination
leaf disc	April	153	12	8
	August	322	16	5
	January	332	30	9
stem tissue	April	194	116	60
	August	191	122	64
	January	211	156	

With reference to Table 1.2,

- (i) calculate the percentage of cultured **stem** tissue explants with **no** fungal or bacterial contamination in January. Write your answer in the appropriate box in the table;  
Show your working in the space below.

[2]

- (ii) compare the effect of the different methods of taking tissue samples and the time of year on fungal and bacterial contamination of the cultured explants.

.....

.....

.....

..... [3]

- (d) Suggest how the number of contaminated samples could be reduced when collecting explants from the wild.

.....

.....

..... [2]

[Total : 15]

- 2 (a) A selective breeding programme to produce a new variety of rice was begun in 1997 in Vietnam. The programme was based on a disease and pest-resistant variety (IR 59655) from the international rice seed bank in the Philippines.

Explain the importance of maintaining an international seed bank.

.....

.....

.....

.....

.....

.....

.....[4]

- (b) The new hybrid variety, VND 404, was ready for trial planting on 6000 hectares in 2002. The differences between VND 404 and its parent variety, IR 59655, are summarised in Table 2.1.

**Table 2.1**

parent variety IR 59655	new variety VND 404
shorter	taller
longer life cycle	shorter life cycle
smaller yield	greater yield
not able to grow in soil rich in aluminium	able to grow in soil rich in aluminium
less able to compete well with weeds	more able to compete well with weeds

With reference to Table 2.1, explain how the new variety of rice was produced within five years.

.....

.....

.....

.....

.....

.....

.....[4]

[Total : 8]

3 In the garden pea, *Pisum sativum*, the dominant alleles of two unlinked genes, **A/a** and **B/b**, are needed to make the pods tough and inedible. All other genotypes result in soft, edible 'sugar-snap' pea pods.

- Pods with genotypes including the dominant allele **A** have a thin layer of cells lining the pod.
- Pods with genotypes in which the recessive allele **a** is homozygous have no thin lining layer.
- Pods with genotypes including the dominant allele **B** have lignin added to the thin lining layer, when it is present.
- Pods with genotypes in which the recessive allele **b** is homozygous do not have added lignin.

(a) State the phenotypes of pea pods with the following genotypes:

**AAbb** .....

**aaBB** .....[2]

(b) Two pea plants of genotypes **AAbb** and **aaBB** were interbred to give an **F<sub>1</sub>** generation and these in turn were interbred to give an **F<sub>2</sub>** generation.

Draw a genetic diagram of the cross, including gametes, showing the genotypes and phenotypes of the **F<sub>1</sub>** and **F<sub>2</sub>** generations. Give the ratio of phenotypes expected in the **F<sub>2</sub>** generation.



*ratio of F<sub>2</sub> phenotypes* .....

.....[8]

[Total : 10]

- 4 (a) People suffering from the sex-linked recessive genetic disease, haemophilia B, lack a blood clotting protein called factor IX.

In an experimental gene therapy, the dominant allele coding for factor IX was added to the genome of adeno-associated virus (AAV). The genetically modified virus was injected into the thigh muscles of three patients. All three patients then produced small quantities of factor IX. AAV does not appear to stimulate the human immune system.

Explain why it is theoretically easier to perform gene therapy to correct a genetic disease caused by a recessive, rather than by a dominant allele.

.....

.....

.....

.....

.....[3]

- (b) The genetically modified AAV has now been injected into patients' livers.

Suggest why the liver was chosen as the target organ for this gene therapy.

.....

.....

.....[2]

- (c) State two potential hazards of this type of gene therapy.

1. ....

.....

2. ....

.....[2]

[Total : 7]



---

*Copyright Acknowledgements:*

Option 3, Fig. 2.1. © Oxford University Press, 2002.  
Option 3, Fig. 3.1 and 3.2 © Geoff Jones, 2003

Every reasonable effort has been made to trace all copyright holders where the publishers (i.e UCLES) are aware that third-party material has been reproduced. The publishers would be pleased to hear from anyone whose rights we have unwittingly infringed.

University of Cambridge International Examinations is part of the University of Cambridge Local Examinations Syndicate (UCLES), which is itself a department of the University of Cambridge.